

TYPES

- Eén (ZV-1) of twee rijen buizen (ZV-2)

BUIZEN

- Verticaal, rechthoekig 45 x 20 mm

COLLECTOREN

- Horizontaal, achterliggend, rond Ø 35 mm

KLEUREN

- Standaardkleur wit RAL 9016
- Niet verkrijgbaar in kleur Gloss White
- Uitgebreide kleurenkaart zie p. 16

BEVESTIGINGEN

- Muurbevestigingen standaard
- ZV-2 ook verkrijgbaar als vrijstaande opstelling, zie p. 116

TECHNISCH

- Elektrisch lasergelast (onzichtbare lasnaden)
- KTL-grondlaag, poedercoating
- Standaardwerkdruk: 4 bar
- Maximale bedrijfstemperatuur: 110°C

ELEKTRISCH (zie hoofdstuk elektrische radiatoren)

- ✗ Zuiver elektrische radiator in de fabriek vorgevuld
- ✗ Gemengde radiator

TECHNISCHE TEKENINGEN

- Zie p. 119

AANSLUITING

- ✓ Eénpuntsaansluiting voor éénpijpssysteem (radiator speciaal te bestellen) (zie p. 301)
- ✓ Eénpuntsaansluiting voor tweepijpssysteem (radiator speciaal te bestellen) (zie p. 301)
- ✓ Tweepuntsaansluiting voor éénpijpssysteem (aansluiting via de middenaansluiting) (zie p. 300)
- ✓ Tweepuntsaansluiting voor tweepijpssysteem (standaard) (zie p. 300)
- ✗ Geïntegreerd ventiel

AANBEVOLEN AANSLUITING (1188)

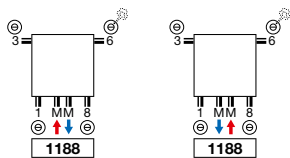

Andere aansluitmogelijkheden, zie p. 117

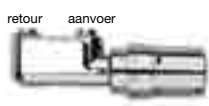

art. nr. 118210300000099
prijs € 155
 Koppelingen, zie p. 313

**AANBEVOLEN VOOR BADKAMER
 IN OPTIE**



handdoekbeugel recht (chrom) art. nr. 118322800000099
prijs € 166

Andere accessoires, zie p. 116

OVER ZANA VERTICAAL

Traditie en trends in perfecte harmonie

De Zana combineert een onklopbaar vermogen met een tijdloze lijnvoering. Een klassieker die blijft bekoren door zijn kracht, zijn klasse en zijn comfort. Het retrogevoel is nooit ver weg. Maar ook de moderniteit is volop aanwezig in dit unieke gamma designradiatoren voor elke woonomgeving, elke ruimte, elke toepassing.



ZANA VERTICAAL (ZV-1)



ZV-1

HOE ZANA VERTICAAL BESTELLEN

Leveringstermijn 15 - 30 werkdagen
(zonder transportduur)

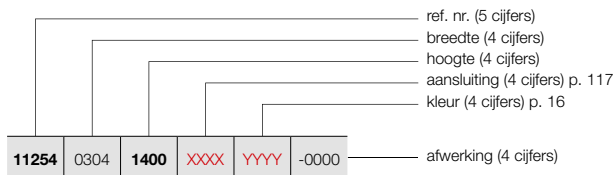

HOE VOORRAADRADIATOR ZANA VERTICAAL BESTELLEN

Leveringstermijn 5 werkdagen
(zonder transportduur)

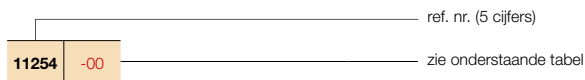

BESTELCODE MAATWERK ZANA VERTICAAL							TECHNISCHE GEGEVENS						STANDAARDKLEUR		ANDERE KLEUREN			
REF. NR.	ZANA VERTICAAL	ZV-1	11254	buizen	breedte (L mm)	hoogte (H mm)	75/65/20 (Watt)	55/45/20 (Watt)	n-exp.	gewicht (kg)	inhoud (l)	el. weerst. (Watt)	prijs RAL 9016	verkorte ref. nr. RAL 9016 voorraad	prijs kleur	verkorte ref. nr. M301 voorraad		
REF. NR. ZANA VERTICAAL ZV-1 : 11254																		
11254	0304	1400	XXXX	YYYY	-0000	8	304	1400	680	359	1,27	18,16	8,24	-	344	-	396	-
		1600				8	304	1600	769	406	1,27	20,72	9,44	-	374	-	430	-
		1800				8	304	1800	859	454	1,28	23,20	10,64	-	404	-	465	-
		2000				8	304	2000	950	502	1,28	25,68	11,68	-	434	-	499	-
		2200				8	304	2200	1042	550	1,28	28,08	12,72	-	464	-	534	-
		2400				8	304	2400	1136	600	1,29	30,56	13,76	-	494	-	568	-
		2600				8	304	2600	1231	650	1,29	33,04	14,80	-	524	-	603	-
		2800				8	304	2800	1327	701	1,29	35,44	15,84	-	554	-	637	-
		3000				8	304	3000	1426	753	1,29	37,92	16,88	-	585	-	673	-
11254	0384	1400	XXXX	YYYY	-0000	10	384	1400	850	449	1,27	22,70	10,30	-	413	-	475	-
		1600				10	384	1600	962	508	1,27	25,90	11,80	-	451	-	519	-
		1800				10	384	1800	1074	567	1,28	29,00	13,30	-	488	11254-03	561	11254-04
		2000				10	384	2000	1188	627	1,28	32,10	14,60	-	526	-	605	-
		2200				10	384	2200	1303	688	1,28	35,10	15,90	-	563	-	647	-
		2400				10	384	2400	1420	750	1,29	38,20	17,20	-	601	-	691	-
		2600				10	384	2600	1539	813	1,29	41,30	18,50	-	639	-	735	-
		2800				10	384	2800	1659	876	1,29	44,30	19,80	-	676	-	777	-
		3000				10	384	3000	1782	941	1,29	47,40	21,10	-	714	-	821	-
11254	0464	1400	XXXX	YYYY	-0000	12	464	1400	1020	539	1,27	27,24	12,36	-	482	-	554	-
		1600				12	464	1600	1154	609	1,27	31,08	14,16	-	527	-	606	-
		1800				12	464	1800	1289	681	1,28	34,80	15,96	-	572	11254-12	658	11254-05
		2000				12	464	2000	1425	752	1,28	38,52	17,52	-	617	11254-01	710	-
		2200				12	464	2200	1563	825	1,28	42,12	19,08	-	663	-	762	-
		2400				12	464	2400	1704	900	1,29	45,84	20,64	-	708	-	814	-
		2600				12	464	2600	1846	975	1,29	49,56	22,20	-	753	-	866	-
		2800				12	464	2800	1991	1051	1,29	53,16	23,76	-	798	-	918	-
		3000				12	464	3000	2139	1130	1,29	56,88	25,32	-	843	-	969	-
11254	0544	1400	XXXX	YYYY	-0000	14	544	1400	1190	628	1,27	31,78	14,42	-	551	-	634	-
		1600				14	544	1600	1346	711	1,27	36,26	16,52	-	604	-	695	-
		1800				14	544	1800	1504	794	1,28	40,60	18,62	-	656	11254-06	754	11254-07
		2000				14	544	2000	1663	878	1,28	44,94	20,44	-	709	11254-08	815	-
		2200				14	544	2200	1824	963	1,28	49,14	22,26	-	762	-	876	-
		2400				14	544	2400	1988	1050	1,29	53,48	24,08	-	814	-	936	-
		2600				14	544	2600	2154	1137	1,29	57,82	25,90	-	867	-	997	-
		2800				14	544	2800	2323	1227	1,29	62,02	27,72	-	920	-	1058	-
		3000				14	544	3000	2495	1318	1,29	66,36	29,54	-	972	-	1118	-
11254	0624	1400	XXXX	YYYY	-0000	16	624	1400	1360	718	1,27	36,32	16,48	-	620	-	713	-
		1600				16	624	1600	1539	813	1,27	41,44	18,88	-	680	-	782	-
		1800				16	624	1800	1719	908	1,28	46,40	21,28	-	741	11254-09	852	11254-10
		2000				16	624	2000	1900	1003	1,28	51,36	23,36	-	801	11254-02	921	-
		2200				16	624	2200	2085	1101	1,28	56,16	25,44	-	861	-	990	-
		2400				16	624	2400	2272	1200	1,29	61,12	27,52	-	921	-	1059	-
		2600				16	624	2600	2462	1300	1,29	66,08	29,60	-	981	-	1128	-
		2800				16	624	2800	2655	1402	1,29	70,88	31,68	-	1041	-	1197	-
		3000				16	624	3000	2852	1506	1,29	75,84	33,76	-	1101	-	1266	-

CE 05 conform EN442-1: radiatoren en convectoren

Voor de warmteafgifte van andere regimes, kijkt u op p. 308 (correctiefactoren)
Prijzen in euro (excl. BTW)

HOE ZANA VERTICAAL BESTELLEN

Leveringstermijn 15 - 30 werkdagen
(zonder transportduur)

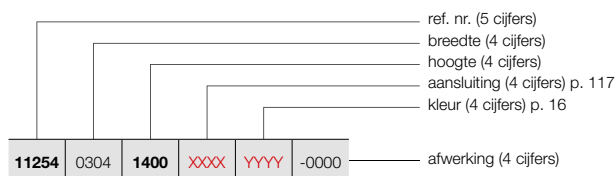

ZANA VERTICAAL (ZV-1)



ZV-1

HOE VOORRAADRADIATOR ZANA VERTICAAL BESTELLEN

Leveringstermijn 5 werkdagen
(zonder transportduur)

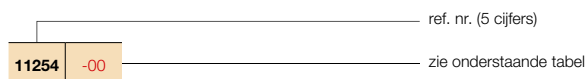

BESTELCODE MAATWERK ZANA VERTICAAL	TECHNISCHE GEGEVENS								STANDAARDKLEUR		ANDERE KLEUREN							
	buizen	breedte (L mm)	hoogte (H mm)	75/65/20 (Watt)	55/45/20 (Watt)	n-exp.	gewicht (kg)	inhoud (l)	el. weerst. (Watt)	prijs RAL 9016	verkorte ref. nr. RAL 9016 voorraad	prijs kleur	verkorte ref. nr. M301 voorraad					
REF. NR. ZANA VERTICAAL ZV-1 : 11254																		
11254	0704	1400	XXXX	YYYY	-0000	18	704	1400	1531	808	1,27	40,86	18,54	-	689	-	792	-
		1600				18	704	1600	1731	914	1,27	46,62	21,24	-	757	-	871	-
		1800				18	704	1800	1933	1021	1,28	52,20	23,94	-	825	-	949	-
		2000				18	704	2000	2138	1129	1,28	57,78	26,28	-	892	11254-11	1026	-
		2200				18	704	2200	2345	1238	1,28	63,18	28,62	-	960	-	1104	-
		2400				18	704	2400	2555	1349	1,29	68,76	30,96	-	1028	-	1182	-
		2600				18	704	2600	2769	1462	1,29	74,34	33,30	-	1095	-	1259	-
		2800				18	704	2800	2987	1577	1,29	79,74	35,64	-	1163	-	1337	-
		3000				18	704	3000	3208	1694	1,29	85,32	37,98	-	1231	-	1416	-
11254	0784	1400	XXXX	YYYY	-0000	20	784	1400	1701	898	1,27	45,40	20,60	-	758	-	872	-
		1600				20	784	1600	1923	1015	1,27	51,80	23,60	-	834	-	959	-
		1800				20	784	1800	2148	1134	1,28	58,00	26,60	-	909	-	1045	-
		2000				20	784	2000	2375	1254	1,28	64,20	29,20	-	984	-	1132	-
		2200				20	784	2200	2606	1376	1,28	70,20	31,80	-	1059	-	1218	-
		2400				20	784	2400	2839	1499	1,29	76,40	34,40	-	1134	-	1304	-
		2600				20	784	2600	3077	1625	1,29	82,60	37,00	-	1209	-	1390	-
		2800				20	784	2800	3319	1753	1,29	88,60	39,60	-	1285	-	1478	-
		3000				20	784	3000	3564	1882	1,29	94,80	42,20	-	1360	-	1564	-
11254	0864	1400	XXXX	YYYY	-0000	22	864	1400	1871	988	1,27	49,94	22,66	-	828	-	952	-
		1600				22	864	1600	2116	1117	1,27	56,98	25,96	-	910	-	1047	-
		1800				22	864	1800	2363	1248	1,28	63,80	29,26	-	993	-	1142	-
		2000				22	864	2000	2613	1380	1,28	70,62	32,12	-	1076	-	1237	-
		2200				22	864	2200	2866	1513	1,28	77,22	34,98	-	1158	-	1332	-
		2400				22	864	2400	3123	1649	1,29	84,04	37,84	-	1241	-	1427	-
		2600				22	864	2600	3385	1788	1,29	90,86	40,70	-	1324	-	1523	-
		2800				22	864	2800	3650	1927	1,29	97,46	43,56	-	1406	-	1617	-
		3000				22	864	3000	3921	2071	1,29	104,28	46,42	-	1489	-	1712	-
11254	0944	1400	XXXX	YYYY	-0000	24	944	1400	2041	1078	1,27	54,48	24,72	-	897	-	1032	-
		1600				24	944	1600	2308	1219	1,27	62,16	28,32	-	987	-	1135	-
		1800				24	944	1800	2578	1361	1,28	69,60	31,92	-	1077	-	1239	-
		2000				24	944	2000	2850	1505	1,28	77,04	35,04	-	1167	-	1342	-
		2200				24	944	2200	3127	1651	1,28	84,24	38,16	-	1257	-	1446	-
		2400				24	944	2400	3407	1799	1,29	91,68	41,28	-	1348	-	1550	-
		2600				24	944	2600	3692	1950	1,29	99,12	44,40	-	1438	-	1654	-
		2800				24	944	2800	3982	2103	1,29	106,32	47,52	-	1528	-	1757	-
		3000				24	944	3000	4277	2259	1,29	113,76	50,64	-	1618	-	1861	-
11254	1024	1400	XXXX	YYYY	-0000	26	1024	1400	2211	1168	1,27	59,02	26,78	-	966	-	1111	-
		1600				26	1024	1600	2500	1320	1,27	67,34	30,68	-	1063	-	1222	-
		1800				26	1024	1800	2793	1475	1,28	75,40	34,58	-	1161	-	1335	-
		2000				26	1024	2000	3088	1631	1,28	83,46	37,96	-	1259	-	1448	-
		2200				26	1024	2200	3388	1789	1,28	91,26	41,34	-	1357	-	1561	-
		2400				26	1024	2400	3691	1949	1,29	99,32	44,72	-	1454	-	1672	-
		2600				26	1024	2600	4000	2112	1,29	107,38	48,10	-	1552	-	1785	-
		2800				26	1024	2800	4314	2278	1,29	115,18	51,48	-	1650	-	1898	-
		3000				26	1024	3000	4634	2447	1,29	123,24	54,86	-	1747	-	2009	-



CE 05 conform EN442-1: radiatoren en convectoren

Voor de warmteafgiftes van andere regimes, kijkt u op p. 308 (correctiefactoren)
Prijzen in euro (excl. BTW)

ZANA VRIJSTAANDE OPSTELLING IN OPTIE

ACCESSOIRES		KLEUR	ART. NR.	€
VRIJSTAANDE OPSTELLING		ZV-2		
		RAL 9016	118100700009016	62
		KLEUR	11810070000xxxx	71
<ul style="list-style-type: none"> Radiatoren in de kleur RAL 9016 en Pergamon krijgen 1 aparte zijbevestiging, 2 voeten (H=150 mm) en 2 rosetten in de betreffende kleur. Radiatoren in overige kleuren krijgen 1 aparte zijbevestiging en 2 voeten (H=150 mm) in de kleur van de radiator + 2 verchroomde rosetten. 				

ZANA ACCESSOIRES IN OPTIE

ACCESSOIRES	BREEDTE RADIATOR	KLEUR	ART. NR.	€
ZV-1 / ZV-2 / ZH-1 / ZH-2 / ZBD / MULTI 1 / MULTI 2				
HANDDOEKBEUGEL RECHT		CHROOM	118322800000099	166
		<ul style="list-style-type: none"> h = 22 mm; b = 720 mm (zelf in te korten); d = 75 mm; a = 56 mm 		
ZV-O				
HANDDOEKBEUGEL ROND	393 mm	ALUMINIUM	118323200000000	201
	473 mm	ALUMINIUM	118323300000000	201
<ul style="list-style-type: none"> Handdoekbeugel rond ZV-O 393 mm; h = 40 mm; b = 518 mm; d = 65 mm ; a = 50 mm Handdoekbeugel rond ZV-O 473 mm; h = 40 mm; b = 598 mm; d = 65 mm ; a = 50 mm 				
ZV-A				
HANDDOEKBEUGEL ROND	268 mm	ALUMINIUM	118323000000000	201
	322 mm	ALUMINIUM	118323100000000	201
<ul style="list-style-type: none"> Handdoekbeugel rond ZV-A 268 mm; h = 40 mm; b = 335 mm; d = 65 mm ; a = 50 mm Handdoekbeugel rond ZV-A 322 mm; h = 40 mm; b = 386 mm; d = 65 mm ; a = 50 mm 				
ZV-1 / ZV-2 / ZH-1 / ZH-2 / ZV-O / ZV-A / ZBD / MULTI 1 / MULTI 2				
KNOP O-RING		CHROOM	118360300000099	28
<ul style="list-style-type: none"> h = 22 mm; b = 22 mm; d = 42 mm 				
ZV-1 / ZV-2 / ZH-1 / ZH-2 / ZV-O / ZV-A / ZBD / MULTI 1 / MULTI 2				
KNOP BREDE GLEUF		CHROOM	118340300000099	28
<ul style="list-style-type: none"> h = 22 mm; b = 22 mm; d = 42 mm 				

d = afstand voorkant accessoire tot voorkant radiator

a = afstand accessoire tot radiator

uit voorraad leverbaar

ZANA VERTICAAL: ZV-1 / ZV-2 (VOORRAAD)

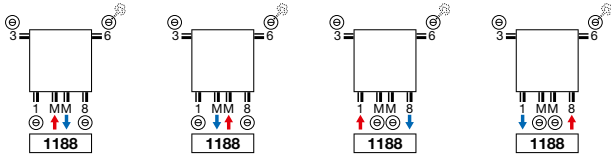

ZANA HORIZONTAAL: ZH-1 / ZH-2

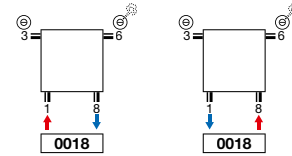

ZANA VERTICAAL: ZV-1 / ZV-2 (NIET-VOORRAAD)

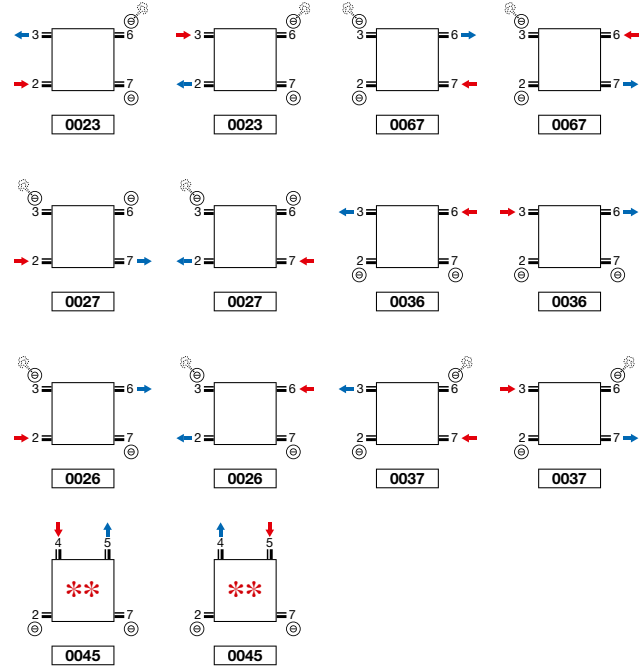
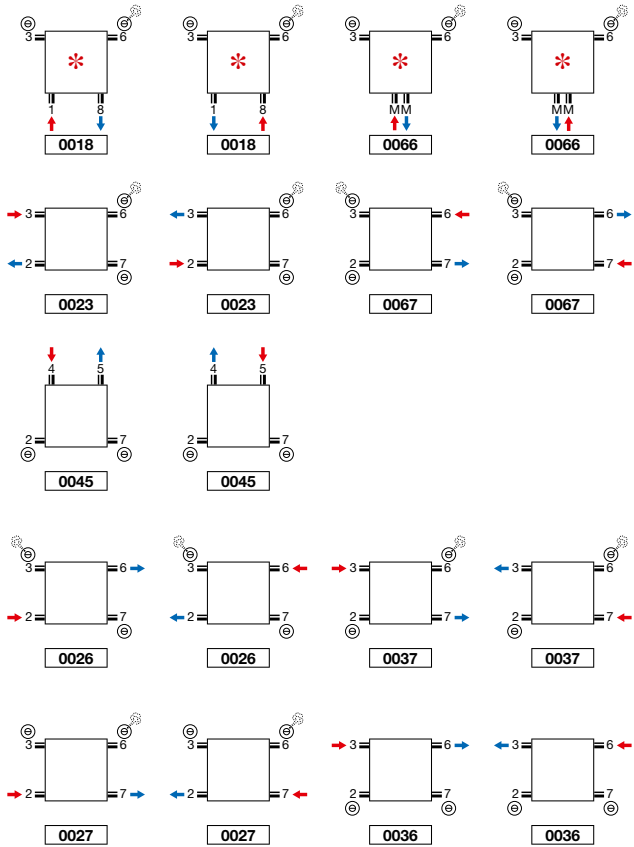

** Niet voor ZH-1 toiletradiator.

* Opmerking ZV-1/ZV-2 8 buizen: 2/3/6/7 altijd open.

ZANA HALFROND: ZV-O / ZANA KWARTROND: ZV-A

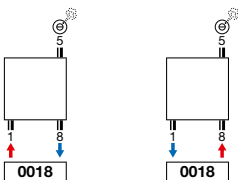

ZANA BAD: ZBD (VOORRAAD) / ZBD (NIET-VOORRAAD)

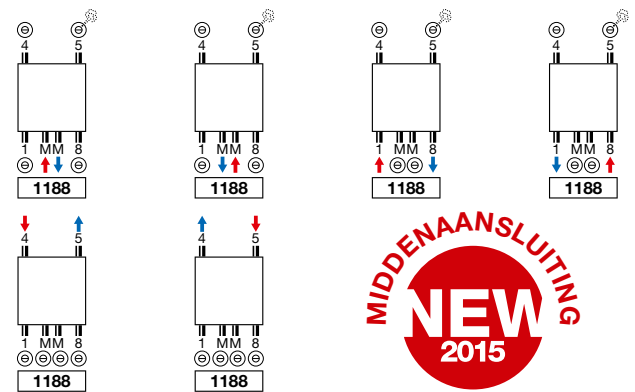

ZANA BAD: ZBD (NIET-VOORRAAD)

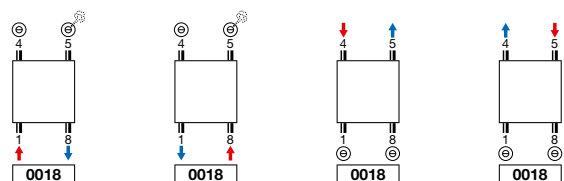

Opmerking: het aansluiten van de radiator kan enkel volgens de getoonde aansluiticonen. Voor elke andere aansluitwijze nemen wij geen verantwoordelijkheid.

ZANA VERTICAAL (ZV-1, ZV-2)

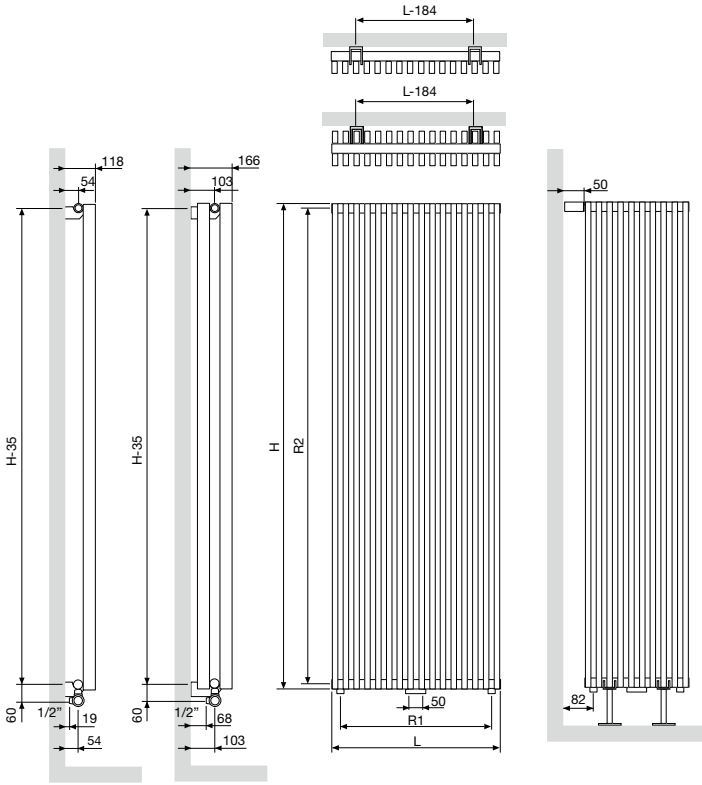

	ZV-1 / ZV-2										
Aantal buizen	8	10	12	14	16	18	20	22	24	26	
Breedte (L)	304	384	464	544	624	704	784	864	944	1024	
Hartafstand tussen de onderaansluitingen 18 (R1)	240	320	400	480	560	640	720	800	880	960	
Hoogte (H)	1400	1600	1800	2000	2200	2400	2600	2800	3000		
Hartafstand tussen de zijansluitingen 23/67 (R2)	1365	1565	1765	1965	2165	2365	2565	2765	2965		
Hartafstand tussen de ophangingen	L-184	H-35									

ZANA HORIZONTAAL (ZH-1, ZH-2)

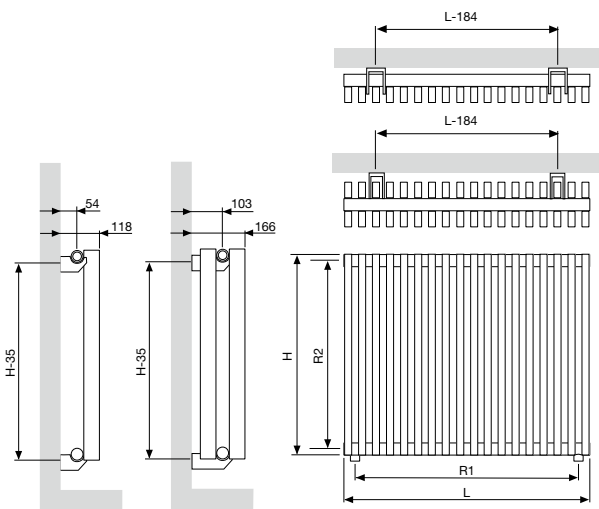

	ZH-1 / ZH-2																		
Breedte (L)	384	704	784	864	944	1024	1104	1184	1264	1424	1584	1744	1904	2064	2224	2384	2544	2704	2864
Hartafstand tussen de onderaansluitingen 18 (R1)	320	640	720	800	880	960	1040	1120	1200	1360	1520	1680	1840	2000	2160	2320	2480	2640	2800
Hoogte (H)	500	600	700																
Hartafstand tussen de zijansluitingen 23/67 (R2)	465	565	665																
Hartafstand tussen de ophangingen	L-184	H-35																	