

VIOLA VERTICAAL (V1-ZB, V1L1-ZB, V2-ZB)



OVER VIOLA VERTICAAL

In de soberheid toont zich de klasse

Een buizenradiator die naadloos combineert met elke woonstijl, door zijn sobere klasse en zijn vanzelfsprekend design. De strak gelijkende voorkant en de ingewerkte zijpanelen staan borg voor een uniforme look en een optimale warmteafgifte. Viola, zo simpel, krachtig en aantrekkelijk kan verwarmingscomfort zijn.

TYPES

- V1-ZB enkele rij buizen, V2-ZB dubbele rij buizen, V1L1-ZB met lamellen

BUIZEN

- Verticaal, platovaal 70 x 10 mm

COLLECTOREN

- Horizontaal, vierkant, achterliggend 34 x 34 mm

KLEUREN

- Standaardkleur wit RAL 9016
- Niet verkrijgbaar in kleuren Gloss White en Jet Black
- Uitgebreide kleurenkaart zie p. 16

SPECIAAL

- Bij type V1L1-ZB is 1 rij stalen lamellen ter verhoging van de warmteafgifte op de platovale buizen gepuntlast.
- Wordt standaard geleverd met 2 zijbekledingen.
- mm aansluiting alleen mogelijk bij even aantal buizen.

BEVESTIGINGEN

- Muurbevestigingen standaard
- V2-ZB ook verkrijgbaar als vrijstaande opstelling, zie p. 150.

TECHNISCH

- Weerstandsgelast (onzichtbare lasnaden)
- KTL-grondlaag, poedercoating
- Standaardwerkdruk: 4 bar. Meerprijs hogere werkdruk (10 bar): +10%
- De leveringstermijn van radiator met een hogere werkdruk is 1 week extra.
- Maximale bedrijfstemperatuur: 110°C

ELEKTRISCH (zie hoofdstuk elektrische radiatoren)

- ✓ Zuiver elektrische radiator in de fabriek voorgevuld
- ✗ Gemengde radiator

TECHNISCHE TEKENINGEN

- Zie p. 153

AANSLUITING

- ✓ Eénpuntsaansluiting voor éénpijpsysteem (radiator speciaal te bestellen) (zie p. 301)
- ✓ Eénpuntsaansluiting voor tweepijpsysteem (radiator speciaal te bestellen) (zie p. 301)
- ✓ Tweepuntsaansluiting voor éénpijpsysteem (aansluiting via de middenaansluiting) (zie p. 300)
- ✓ Tweepuntsaansluiting voor tweepijpsysteem (standaard) (zie p. 300)
- ✗ Geïntegreerd ventiel

AANBEVOLEN AANSLUITING (1008)

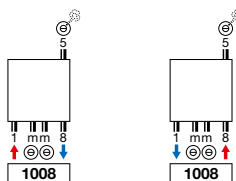

Andere aansluitmogelijkheden, zie p. 152



art. nr. 118200100009016
prijs € 91

Koppelingen, zie p. 313

AANBEVOLEN VOOR BADKAMER IN OPTIE



handdoekbeugel (chromo)
art. nr. 118322300000099
prijs € 166

Andere accessoires, zie p. 151

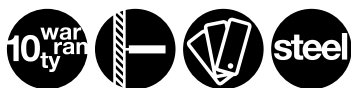

V2-ZB

HOE VIOLA VERTICAAL BESTELLEN

Leveringstermijn 15 - 30 werkdagen
(zonder transportduur)

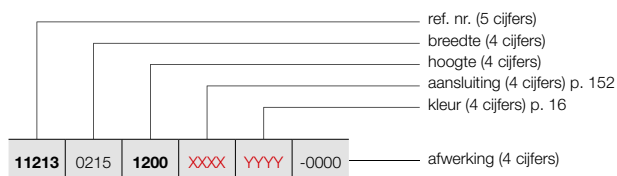

HOE VOORRAADRADIATOR VIOLA VERTICAAL BESTELLEN

Leveringstermijn 5 werkdagen
(zonder transportduur)

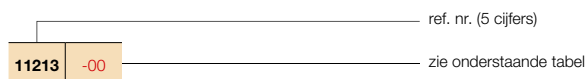

VIOLA VERTICAAL (V1L1-ZB)



V1L1-ZB

BESTELCODE MAATWERK VIOLA VERTICAAL	TECHNISCHE GEGEVENS									STANDAARDKLEUR		ANDERE KLEUREN					
	buizen	breedte (L mm)	hoogte (H mm)	75/65/20 (Watt)	55/45/20 (Watt)	n-exp.	gewicht (kg)	inhoud (l)	el. weerst. (Watt)	prijs RAL 9016	verkorte ref. nr. RAL 9016 voorraad	prijs kleur					
REF. NR. VIOLA VERTICAAL V1L1-ZB : 11213																	
11213	0215	1200	XXXX	YYYY	-0000	3	215	1200	421	211	1,35	10,65	2,04	-	302	-	347
		1400				3	215	1400	480	241	1,35	12,06	2,31	-	329	-	378
		1600				3	215	1600	538	270	1,35	13,47	2,61	-	355	-	408
		1800				3	215	1800	594	298	1,35	15,12	2,88	-	382	-	439
		2000				3	215	2000	649	326	1,35	16,77	3,15	-	408	-	469
		2200				3	215	2200	702	354	1,34	18,45	3,45	-	436	-	501
		2400				3	215	2400	754	382	1,33	20,19	3,75	-	462	-	531
11213	0288	1200	XXXX	YYYY	-0000	4	288	1200	562	282	1,35	14,20	2,72	-	355	-	408
		1400				4	288	1400	640	321	1,35	16,08	3,08	-	389	-	447
		1600				4	288	1600	717	360	1,35	17,96	3,48	-	422	-	485
		1800				4	288	1800	792	397	1,35	20,16	3,84	-	456	-	524
		2000				4	288	2000	865	434	1,35	22,36	4,20	-	489	-	562
		2200				4	288	2200	936	472	1,34	24,60	4,60	-	523	-	601
		2400				4	288	2400	1006	510	1,33	26,92	5,00	-	556	-	639
11213	0360	1200	XXXX	YYYY	-0000	5	360	1200	702	352	1,35	17,75	3,40	-	408	-	469
		1400				5	360	1400	801	402	1,35	20,10	3,85	-	449	-	516
		1600				5	360	1600	897	450	1,35	22,45	4,35	-	489	-	562
		1800				5	360	1800	990	497	1,35	25,20	4,80	-	529	-	608
		2000				5	360	2000	1081	542	1,35	27,95	5,25	-	571	-	657
		2200				5	360	2200	1170	590	1,34	30,75	5,75	-	611	-	703
		2400				5	360	2400	1257	637	1,33	33,65	6,25	-	650	-	748
11213	0433	0600	XXXX	YYYY	-0000	6	433	600	403	207	1,30	11,15	2,40	-	283	-	325
		1200				6	433	1200	842	422	1,35	21,30	4,08	-	462	-	531
		1400				6	433	1400	961	482	1,35	24,12	4,62	-	509	-	585
		1600				6	433	1600	1076	540	1,35	26,94	5,22	-	556	-	639
		1800				6	433	1800	1188	596	1,35	30,24	5,76	-	604	-	695
		2000				6	433	2000	1297	651	1,35	33,54	6,30	-	650	-	748
		2200				6	433	2200	1404	708	1,34	36,90	6,90	-	698	-	803
		2400				6	433	2400	1508	764	1,33	40,38	7,50	-	745	-	857
11213	0505	1200	XXXX	YYYY	-0000	7	505	1200	983	493	1,35	24,85	4,76	-	516	-	593
		1400				7	505	1400	1121	562	1,35	28,14	5,39	-	570	-	656
		1600				7	505	1600	1255	630	1,35	31,43	6,09	-	623	-	716
		1800				7	505	1800	1386	695	1,35	35,28	6,72	-	678	-	780
		2000				7	505	2000	1513	759	1,35	39,13	7,35	-	731	-	841
		2200				7	505	2200	1638	826	1,34	43,05	8,05	-	784	-	902
		2400				7	505	2400	1760	892	1,33	47,11	8,75	-	838	-	964
11213	0578	1200	XXXX	YYYY	-0000	8	578	1200	1123	563	1,35	28,40	5,44	-	570	-	656
		1400				8	578	1400	1281	643	1,35	32,16	6,16	-	629	-	723
		1600				8	578	1600	1434	720	1,35	35,92	6,96	-	690	-	794
		1800				8	578	1800	1584	795	1,35	40,32	7,68	-	751	11213-01	864
		2000				8	578	2000	1730	868	1,35	44,72	8,40	-	812	11213-02	934
		2200				8	578	2200	1872	944	1,34	49,20	9,20	-	871	-	1002
		2400				8	578	2400	2011	1019	1,33	53,84	10,00	-	932	-	1072

CE05 conform EN442-1: radiatoren en convectoren

Voor de warmteafgiftes van andere regimes, kijkt u op p. 308 (correctiefactoren)
Prijzen in euro (excl. BTW)

VIOLA VERTICAAL (V1L1-ZB)

HOE VIOLA VERTICAAL BESTELLEN

Leveringstermijn 15 - 30 werkdagen
(zonder transportduur)



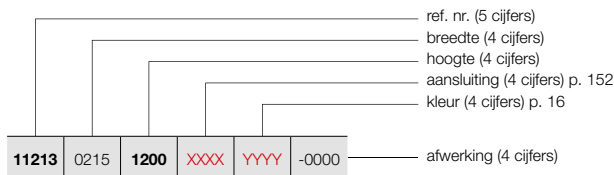

V1L1-ZB



BESTELCODE MAATWERK VIOLA VERTICAAL							TECHNISCHE GEGEVENS						STANDAARDKLEUR		ANDERE KLEUREN		
REF. NR.	VIOLA VERTICAAL	V1L1-ZB	: 11213	buizen	breedte (L mm)	hoogte (H mm)	75/65/20 (Watt)	55/45/20 (Watt)	n-exp.	gewicht (kg)	inhoud (l)	el. weerst. (Watt)	prijs RAL 9016	verkorte ref. nr. RAL 9016 voorraad	prijs kleur		
11213	0650	1200	XXXX	YYYY	-0000	9	650	1200	1264	634	1,35	31,95	6,12	-	623	-	716
		1400				9	650	1400	1441	723	1,35	36,18	6,93	-	690	-	794
		1600				9	650	1600	1614	810	1,35	40,41	7,83	-	757	-	871
		1800				9	650	1800	1782	894	1,35	45,36	8,64	-	824	-	948
		2000				9	650	2000	1946	976	1,35	50,31	9,45	-	892	-	1026
		2200				9	650	2200	2106	1062	1,34	55,35	10,35	-	959	-	1103
		2400				9	650	2400	2263	1147	1,33	60,57	11,25	-	1026	-	1180
11213	0723	1200	XXXX	YYYY	-0000	10	723	1200	1404	704	1,35	35,50	6,80	-	676	-	777
		1400				10	723	1400	1601	803	1,35	40,20	7,70	-	751	-	864
		1600				10	723	1600	1793	900	1,35	44,90	8,70	-	824	-	948
		1800				10	723	1800	1980	994	1,35	50,40	9,60	-	899	-	1034
		2000				10	723	2000	2162	1085	1,35	55,90	10,50	-	972	-	1118
		2200				10	723	2200	2340	1180	1,34	61,50	11,50	-	1046	-	1203
		2400				10	723	2400	2514	1274	1,33	67,30	12,50	-	1121	-	1289
11213	0795	1200	XXXX	YYYY	-0000	11	795	1200	1544	775	1,35	39,05	7,48	-	730	-	840
		1400				11	795	1400	1761	884	1,35	44,22	8,47	-	812	-	934
		1600				11	795	1600	1972	989	1,35	49,39	9,57	-	891	-	1025
		1800				11	795	1800	2178	1093	1,35	55,44	10,56	-	972	-	1118
		2000				11	795	2000	2378	1193	1,35	61,49	11,55	-	1054	-	1212
		2200				11	795	2200	2574	1298	1,34	67,65	12,65	-	1133	-	1303
		2400				11	795	2400	2765	1402	1,33	74,03	13,75	-	1214	-	1396
11213	0868	1200	XXXX	YYYY	-0000	12	868	1200	1685	845	1,35	42,60	8,16	-	784	-	902
		1400				12	868	1400	1921	964	1,35	48,24	9,24	-	870	-	1001
		1600				12	868	1600	2152	1080	1,35	53,88	10,44	-	958	-	1102
		1800				12	868	1800	2376	1192	1,35	60,48	11,52	-	1045	-	1202
		2000				12	868	2000	2594	1302	1,35	67,08	12,60	-	1133	-	1303
		2200				12	868	2200	2808	1416	1,34	73,80	13,80	-	1221	-	1404
		2400				12	868	2400	3017	1529	1,33	80,76	15,00	-	1308	-	1504
11213	1013	1200	XXXX	YYYY	-0000	14	1013	1200	1966	986	1,35	49,70	9,52	-	891	-	1025
		1400				14	1013	1400	2241	1124	1,35	56,28	10,78	-	992	-	1141
		1600				14	1013	1600	2510	1259	1,35	62,86	12,18	-	1092	-	1256
		1800				14	1013	1800	2772	1391	1,35	70,56	13,44	-	1194	-	1373
		2000				14	1013	2000	3027	1519	1,35	78,26	14,70	-	1294	-	1488
		2200				14	1013	2200	3276	1652	1,34	86,10	16,10	-	1396	-	1605
		2400				14	1013	2400	3520	1784	1,33	94,22	17,50	-	1497	-	1722

CE₀₅ conform EN442-1: radiatoren en convectoren

Voor de warmteafgiftes van andere regimes, kijkt u op p. 308 (correctiefactoren)
 Prijzen in euro (excl. BTW)

ACCESSOIRES	KLEUR	ART. NR.	€
HANDDOEKBEUGEL 	V1-ZB / V1L1-ZB / V2-ZB H1-RO / H1L1-RO / H2-RO / H2L1-RO / H2L2-RO		
	CHROOM	118322300000099	166
<ul style="list-style-type: none"> h = 22 mm; b = 670 mm; d = 85 mm; a = 60 mm 			
KNOP O-RING 	V1-ZB / V1L1-ZB / V2-ZB H1-RO / H1L1-RO / H2-RO / H2L1-RO / H2L2-RO		
	CHROOM	118360000000099	28
<ul style="list-style-type: none"> h = 22 mm; b = 22 mm; d = 42 mm 			
KNOP BREDE GLEUF 	V1-ZB / V1L1-ZB / V2-ZB H1-RO / H1L1-RO / H2-RO / H2L1-RO / H2L2-RO		
	CHROOM	118340000000099	28
<ul style="list-style-type: none"> h = 22 mm; b = 22 mm; d = 42 mm 			
DROOG- EN STAPELREK SMAL 	V1-ZB / V1L1-ZB / V2-ZB H1-RO / H1L1-RO / H2-RO / H2L1-RO / H2L2-RO		
	CHROOM	118300700000099	166
<ul style="list-style-type: none"> h = 22 mm; b = 385 mm; d = 163 mm; a = 30 mm 			
DROOG- EN STAPELREK BREED 	V1-ZB / V1L1-ZB / V2-ZB H1-RO / H1L1-RO / H2-RO / H2L1-RO / H2L2-RO		
	CHROOM	118301000000099	166
<ul style="list-style-type: none"> h = 22 mm; b = 530 mm; d = 163 mm; a = 30 mm 			

d = afstand voorkant accessoire tot voorkant radiator
a = afstand accessoire tot radiator
uit voorraad leverbaar

VIOLA VERTICAAL: V1-ZB / V1L1-ZB / V2-ZB (VOORRAAD)

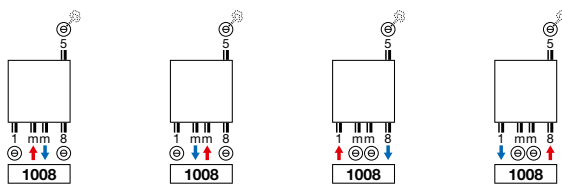

VIOLA HORIZONTAAL: H1-RO / H1L1-RO / H2-RO / H2L1-RO / H2L2-RO

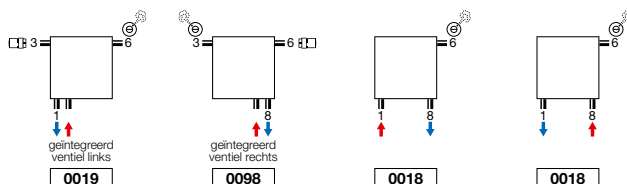

- mm aansluiting alleen mogelijk bij even aantal buizen.

VIOLA VERTICAAL: V1-ZB / V1L1-ZB / V2-ZB (NIET-VOORRAAD)

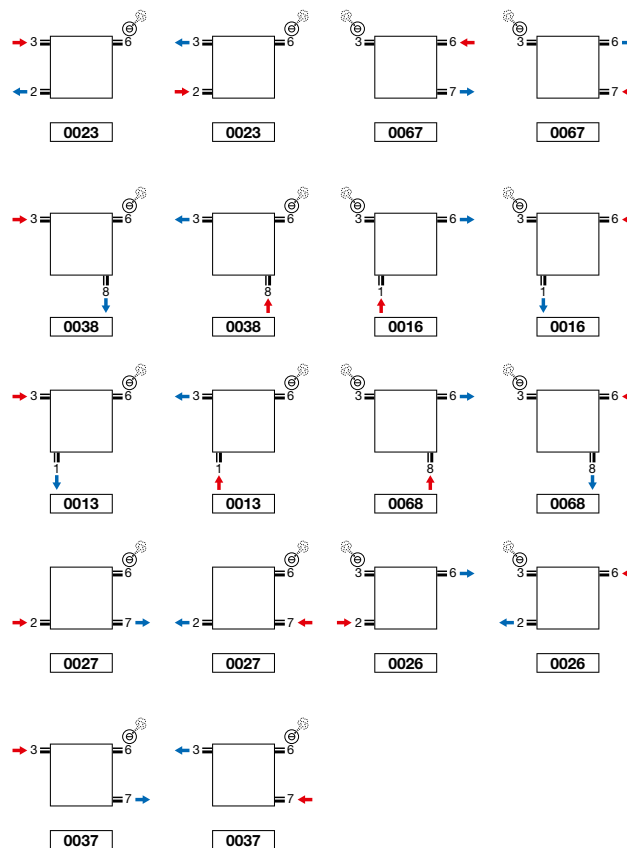
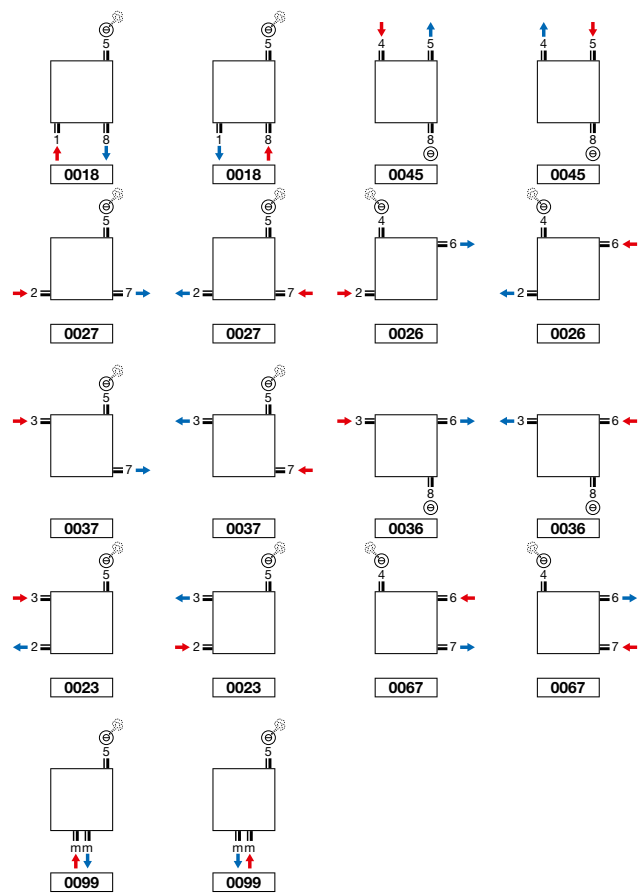

- Geïntegreerd ventiel: meerprijs €102 (zie p. 302)

Opmerking: het aansluiten van de radiator kan enkel volgens de getoonde aansluiticonen. Voor elke andere aansluitwijze nemen wij geen verantwoordelijkheid.

VIOLA VERTICAAL (V1-ZB, V1L1-ZB, V2-ZB)

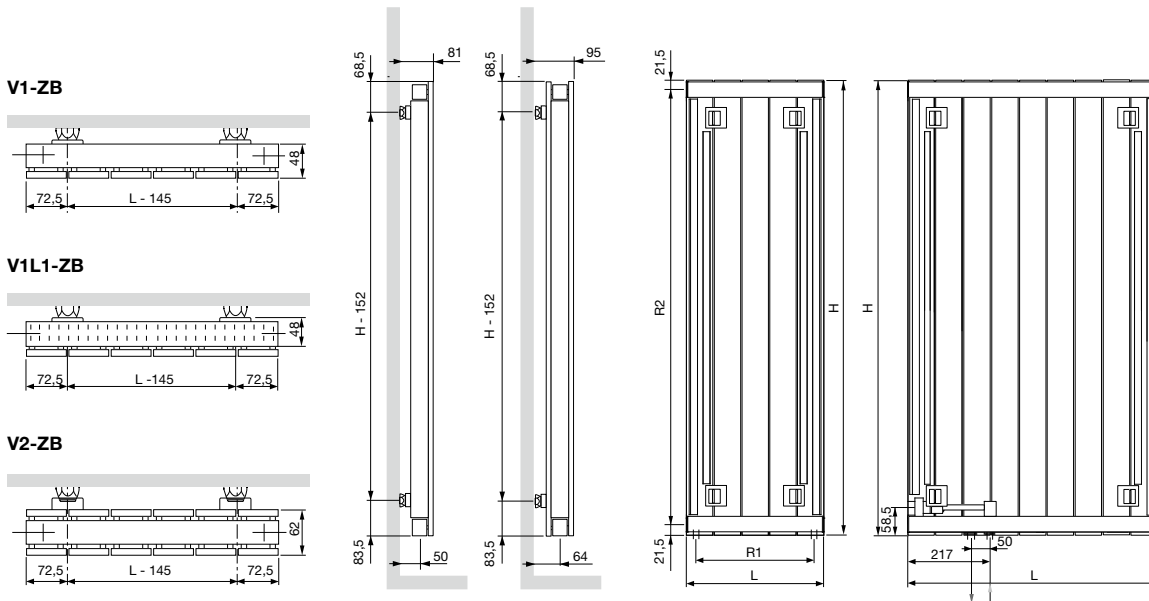

	V1-ZB / V2-ZB / V1L1-ZB													
Aantal buizen	3	4	5	6	7	8	9	10	11	12	14			
Breedte (L)	215	288	360	433	505	578	650	723	795	868	1013			
Hartafstand tussen de onderaansluitingen 18 (R1)	165	238	310	383	455	528	600	673	745	818	963			
Hoogte (H)	600	1200	1400	1600	1800	2000	2200	2400						
Hartafstand tussen de zijaansluitingen 23/67 (R2)	557	1157	1357	1557	1757	1957	2157	2357						
Hartafstand tussen de ophangingen	L-145	H-152												

VIOLA VERTICAAL (V2-ZB) VRIJSTAANDE OPSTELLING

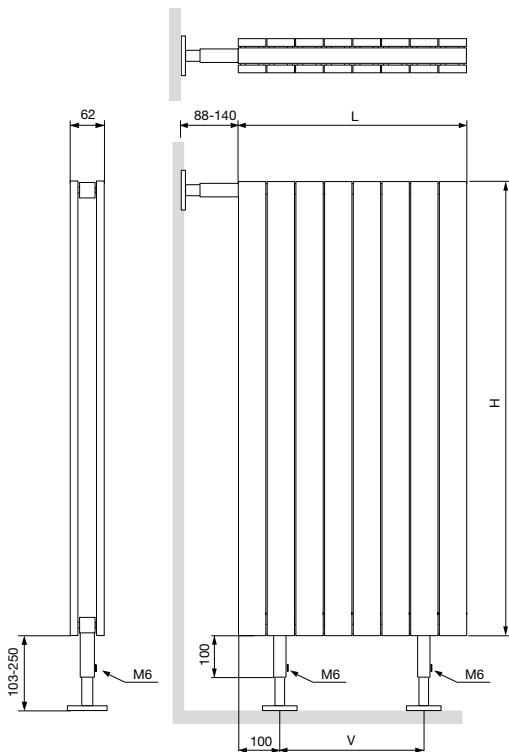

	VRIJSTAAND V2-ZB													
Breedte (L)	215	288	360	433	505	578	650	723	795	868	1013			
Hartafstand tussen de voeten (V)	15	88	160	233	305	378	450	523	595	668	813			